

# Eclipse 50

SURFACE STEM



## SPECIFICATION SHEET

### Eclipse 50



#### Model 1670

**Type**  
S Surface - STEM

**Size**

|        |                |
|--------|----------------|
| 24     | 24.8" [631mm]  |
| 36     | 36.3" [921mm]  |
| 48     | 47.7" [1211mm] |
| 60     | 59.1" [1500mm] |
| 72     | 70.5" [1790mm] |
| Custom |                |

#### Wattage<sup>1,2</sup>

| Direct <sup>3</sup> | Indirect <sup>4</sup> |
|---------------------|-----------------------|
| <b>24"</b>          |                       |
| LD 18W (2400lm)     | LI 18W (2400lm)       |
| MD 36W (4460lm)     | MI 36W (4460lm)       |
| <b>36"</b>          |                       |
| LD 27W (3600lm)     | LI 27W (3600lm)       |
| MD 54W (6685lm)     | MI 54W (6685lm)       |
| <b>48"</b>          |                       |
| LD 36W (4800lm)     | LI 36W (4800lm)       |
| MD 72W (8915lm)     | MI 72W (8915lm)       |
| <b>60"</b>          |                       |
| LD 45W (6000lm)     | LI 45W (6000lm)       |
| MD 90W (11145lm)    | MI 90W (11145lm)      |
| <b>72"</b>          |                       |
| LD 54W (7200lm)     | LI 54W (7200lm)       |
| MD 108W (13375lm)   | MI 108W (13375lm)     |

XD - No Direct      XI - No Indirect

**Color Temp<sup>5</sup>**

|    |      |
|----|------|
| 30 | 3000 |
| 35 | 3500 |
| 40 | 4000 |

**Voltage**  
2 220/240 Volt

**Driver**  
RD Remote

#### Control - RD

S Non-dim  
D010 0-10V  
DALI DALI  
SWD SwitchDIM

#### Diffuser Bottom

SW Satin opal acrylic  
CB Aluminum - painted to match the fixture

#### Diffuser Top

SA Satin clear acrylic  
CT Aluminum - painted to match the fixture

#### Finish

19 Painted anodized aluminum - RAL 9006 matte  
21 Painted white - RAL 9010 matte  
26 Painted black - RAL 9005 matte  
22 Painted custom color

#### Mounting

S Stem - remote driver

#### Circuit

CS Circuit - Single  
CD Circuit - Dual

#### Notes

- Nominal lumens value specified
- Linear LED board, constant voltage 24 Volt
- For no Direct light specify XD
- For no Indirect light specify XI
- 90+ CRI standard

#### Example fixture number:

1670 - S - 24 - LD - LI - 30 - 2 - RD - S - SW - SA - 19 - S - CS

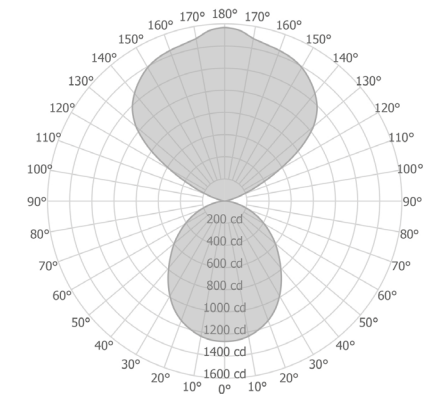
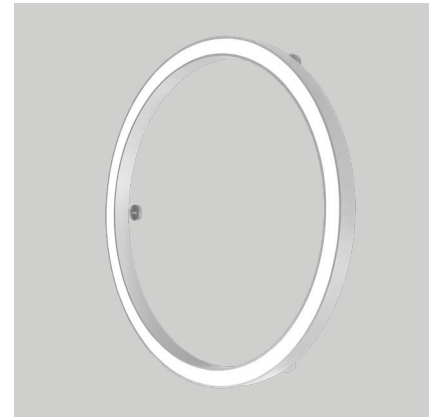

# Eclipse 50

SURFACE - STEM



Eclipse 50 is available in pendant and surface versions. Offered in a wide variety of standard diameters and lumen packages, the luminaire is available for as much modification as your imagination will allow, including ovals and squares.



| Size   |                 |
|--------|-----------------|
| 24     | 24.8" [631mm]   |
| 36     | 36.3" [921mm]   |
| 48     | 47.7" [1,211mm] |
| 60     | 59.1" [1,500mm] |
| 72     | 70.5" [1,790mm] |
| Custom |                 |



\* 50mm x 50mm fixture body profile

# Eclipse 50

SURFACE STEM



## SPECIFICATION SHEET

Eclipse 50

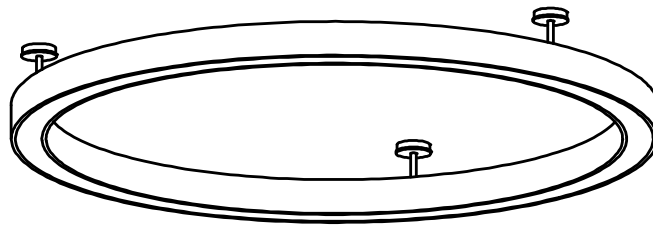
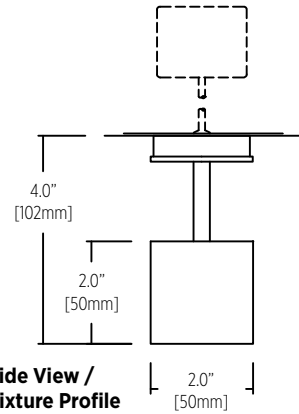
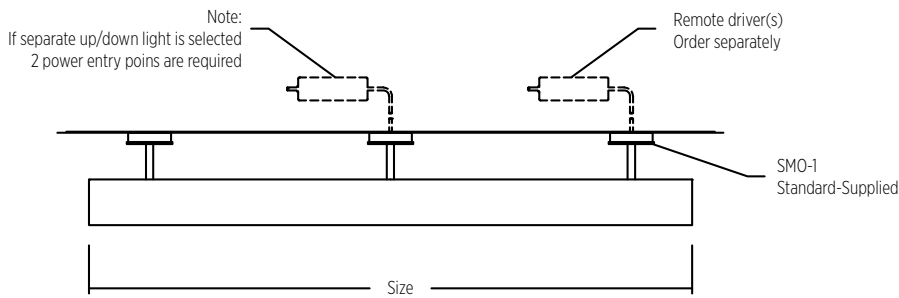

### SMO-1 Standard - Supplied

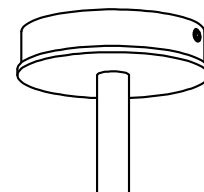
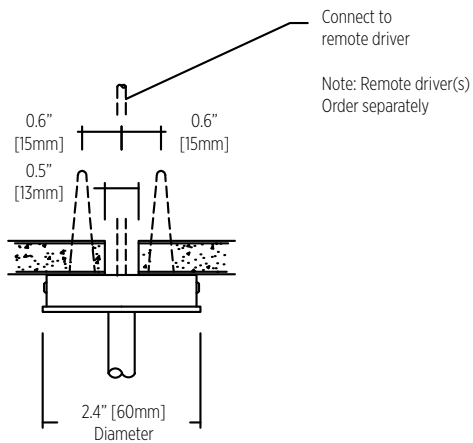

Mounting Option - Stem, Power / Non Power  
Installed in drywall or wood  
Application wall or ceiling